

**HF**  
Halogen Free

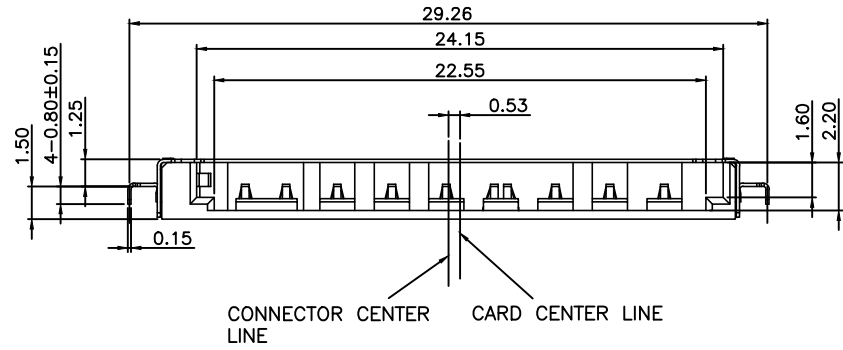

REV.	ECN NO.	LOCATION	DESCRIPTION	DATE	DESIGN
1			INITIAL RELEASE	2019.07.10	Alex_Z
3			UPDATE NOTES	2019.08.30	Alex_Z

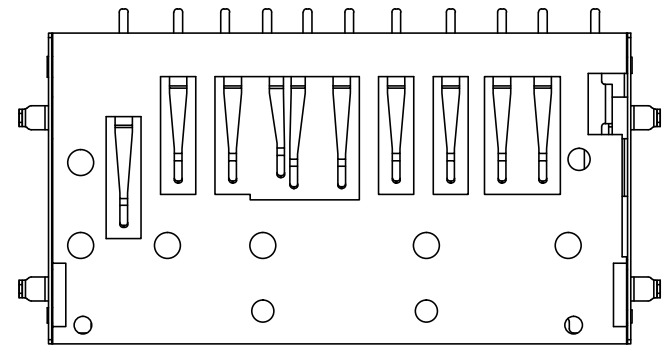
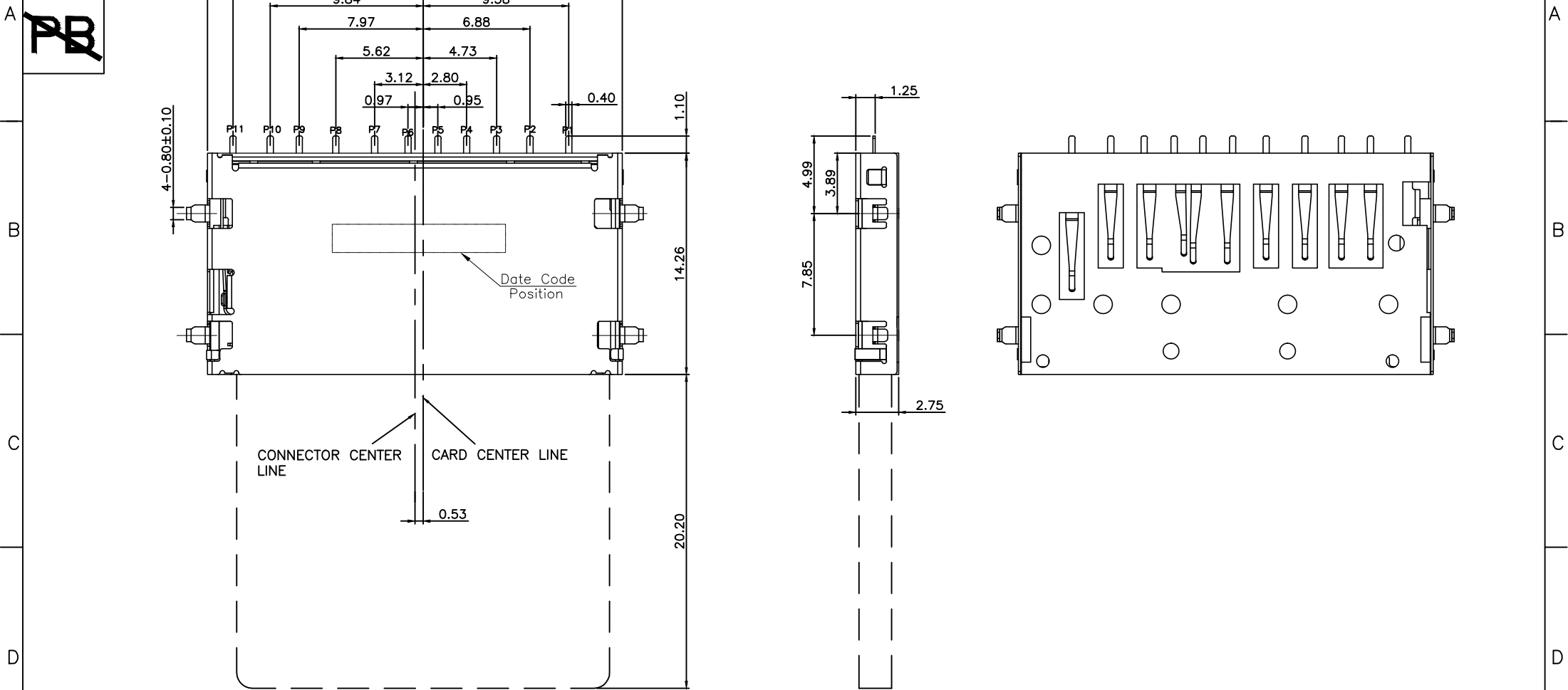

REEL	30u"	570B31-004H
	15u"	570B31-003H
	5u"	570B31-002H
	G/F	570B31-001H
PACKING	PLATING	PART NO.

DIM	TOL	DIM	TOL
x.	±0.30	x.	±3°
.x			
.xx	±0.25		
.xxx			

**DEREN**  
SHENZHEN DEREN ELECTRONIC CO., LTD

CUSTOMER DRAWING		DATE		TITLE: SD CARD NON PUSH SINK=1.50mm H=2.75mm	
DESIGN: Alex_Z		2019.08.30		P/N: SEE TABLE	
CHECK:				SHEET: 1/3	
APPROVAL:				SCALE: 1:1 UNIT: mm	

DRAW NO.	***
REV.	3

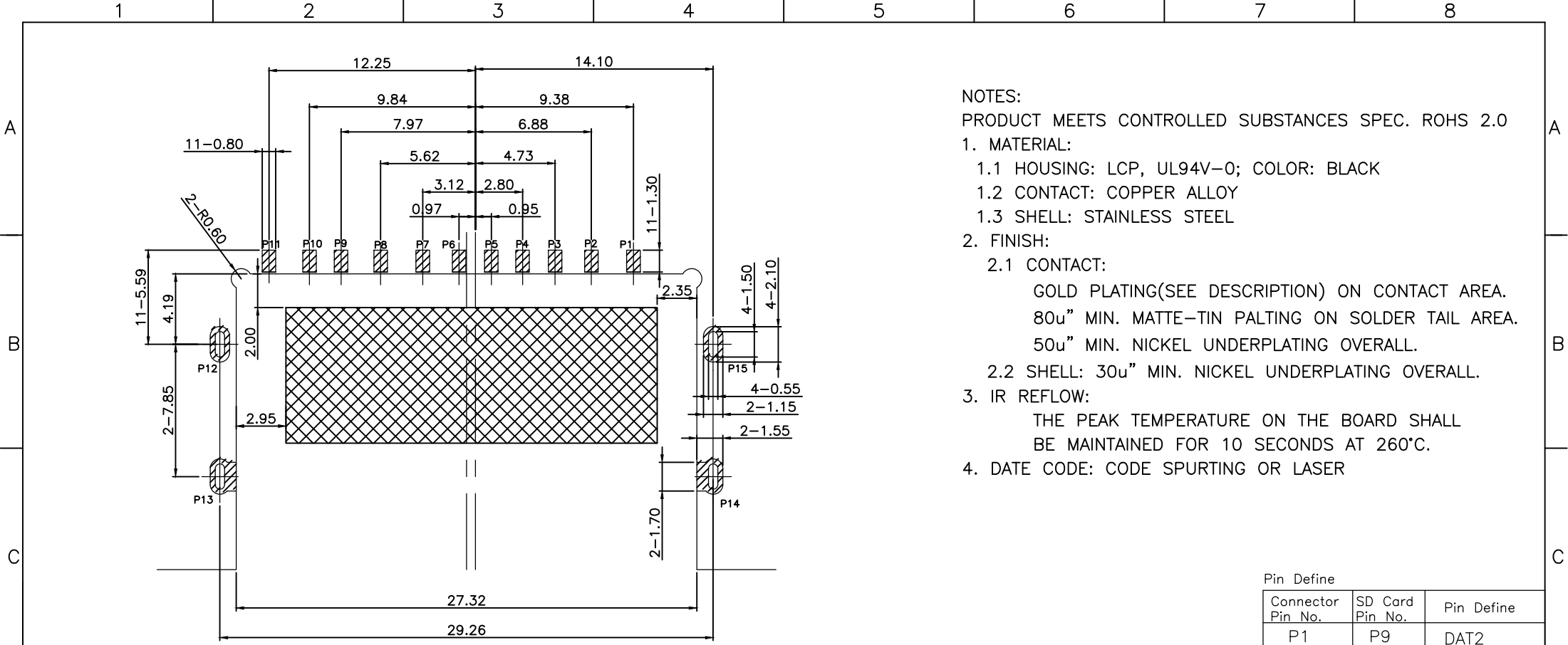

RECOMMEND P.C.B LAYOUT  
TOLERANCE  $\pm 0.05$

- PAD
- No trace , no test point,  
no via hole, no ground area

- NOTES:  
PRODUCT MEETS CONTROLLED SUBSTANCES SPEC. ROHS 2.0
1. MATERIAL:
    - 1.1 HOUSING: LCP, UL94V-0; COLOR: BLACK
    - 1.2 CONTACT: COPPER ALLOY
    - 1.3 SHELL: STAINLESS STEEL
  2. FINISH:
    - 2.1 CONTACT:
      - GOLD PLATING(SEE DESCRIPTION) ON CONTACT AREA.
      - 80u" MIN. MATTE-TIN PLATING ON SOLDER TAIL AREA.
      - 50u" MIN. NICKEL UNDERPLATING OVERALL.
    - 2.2 SHELL: 30u" MIN. NICKEL UNDERPLATING OVERALL.
  3. IR REFLOW:
    - THE PEAK TEMPERATURE ON THE BOARD SHALL BE MAINTAINED FOR 10 SECONDS AT 260°C.
  4. DATE CODE: CODE SPURTING OR LASER

Pin Define		
Connector Pin No.	SD Card Pin No.	Pin Define
P1	P9	DAT2
P2	P1	DAT3
P3	P2	CMD
P4		CD
P5	P3	VSS1
P6	P4	VDD
P7	P5	CLK
P8	P6	VSS2
P9	P7	DATO
P10	P8	DAT1
P11		W/P
P12~P15		GND

WITHOUT CARD	CARD INSERTED:LOCK	CARD INSERTED:UNLOCK
W/P    GND 	W/P    GND 	W/P    GND 
C/D    VSS1 P3 	C/D    VSS1 P3 	C/D    VSS1 P3 

DIM	TOL	DIM	TOL
x.	$\pm 0.30$	x.	$\pm 3^\circ$
.x	$\pm 0.25$		
.xx			
.xxx			

**DEREN**  
SHENZHEN DEREN ELECTRONIC CO., LTD

CUSTOMER DRAWING		DATE		TITLE: SD CARD NON PUSH SINK=1.50mm H=2.75mm	
DESIGN:	Alex_Z	2019.08.30	P/N:	SEE TABLE	
CHECK:			SHEET:	2/3	
APPROVAL:			SCALE:	1:1	UNIT: mm

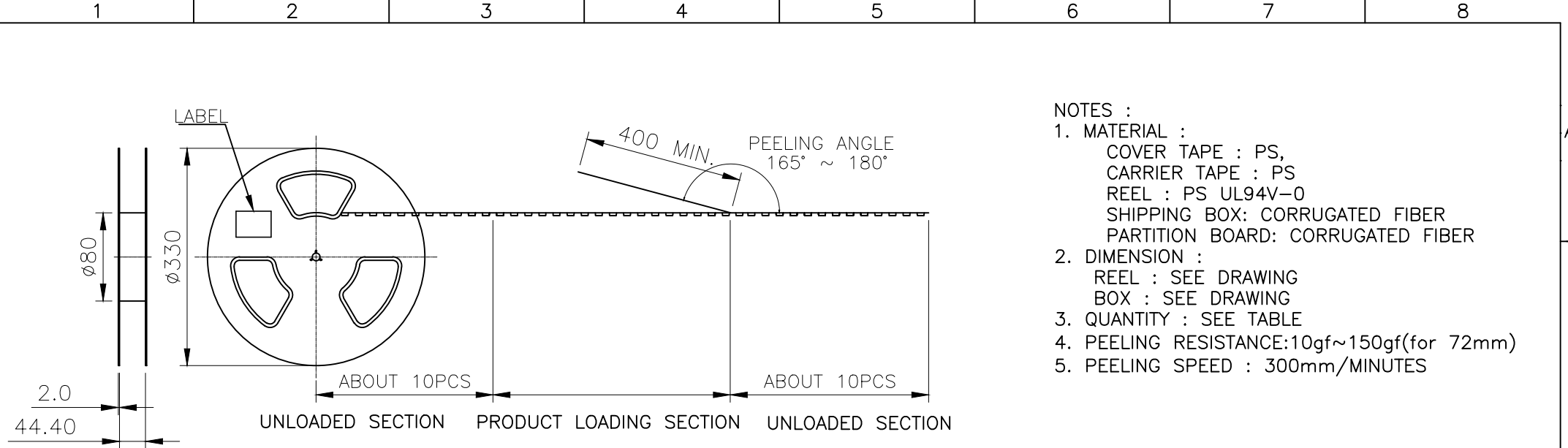

- NOTES :
- MATERIAL :  
 COVER TAPE : PS,  
 CARRIER TAPE : PS  
 REEL : PS UL94V-0  
 SHIPPING BOX: CORRUGATED FIBER  
 PARTITION BOARD: CORRUGATED FIBER
  - DIMENSION :  
 REEL : SEE DRAWING  
 BOX : SEE DRAWING
  - QUANTITY : SEE TABLE
  - PEELING RESISTANCE: 10gf~150gf (for 72mm)
  - PEELING SPEED : 300mm/MINUTES

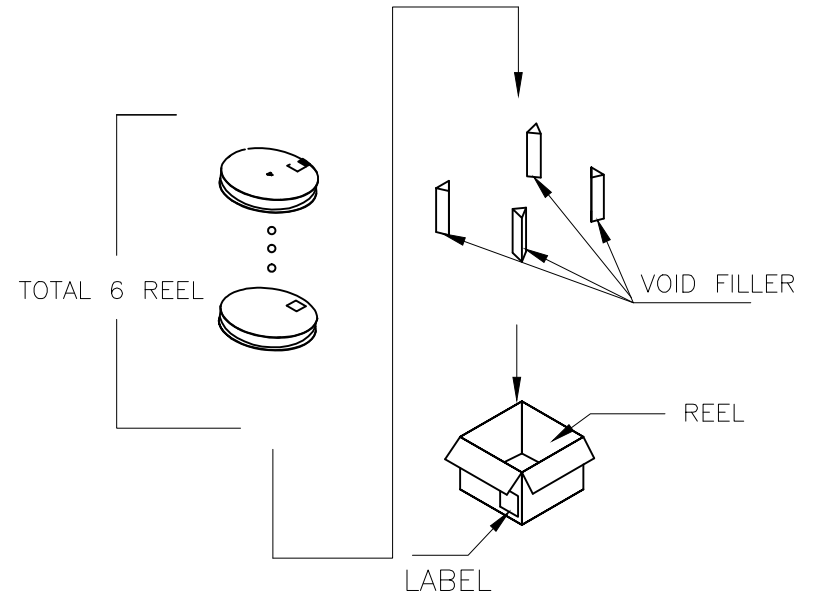
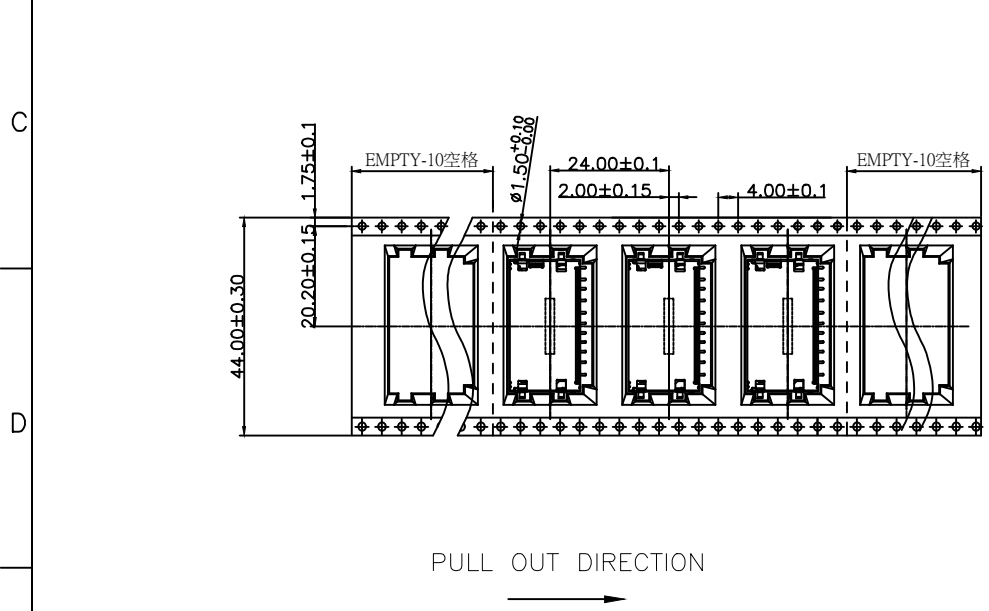

DIM	TOL	DIM	TOL
x		x	
.x		.x	
.xx		.xx	
600	6	3600	
PCS/REEL	REEL/BOX	TOTAL Q'TY	

	<b>DEREN</b> SHENZHEN DEREN ELECTRONIC CO., LTD		
	CUSTOMER DRAWING	DATE	TITLE: SD CARD NON PUSH SINK=1.50mm H=2.75mm
	DESIGN: Alex_Z	2019.08.30	P/N: SEE TABLE
	CHECK:		SHEET: 3/3
REV. 3	APPROVAL:		SCALE: N/A UNIT: mm