

HF
Halogen Free

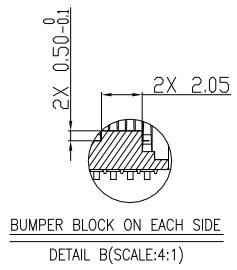

NOTES:
Recommended stencil thickness no less than 0.18mm

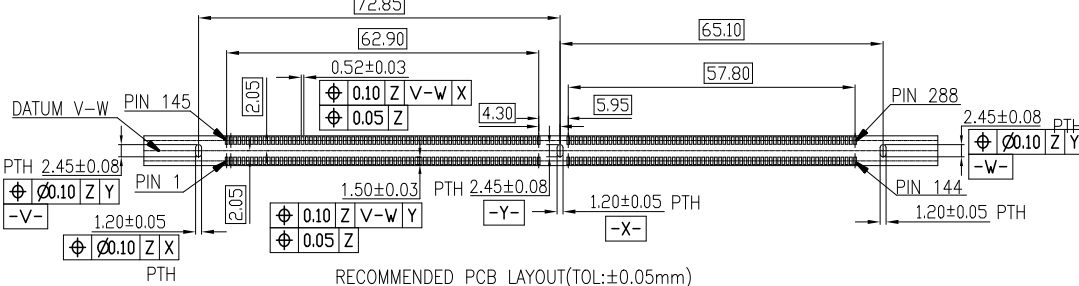
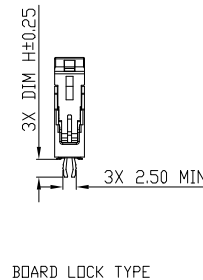
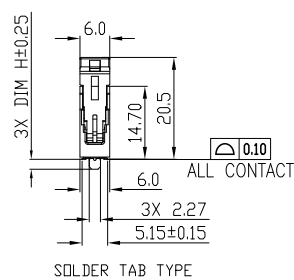
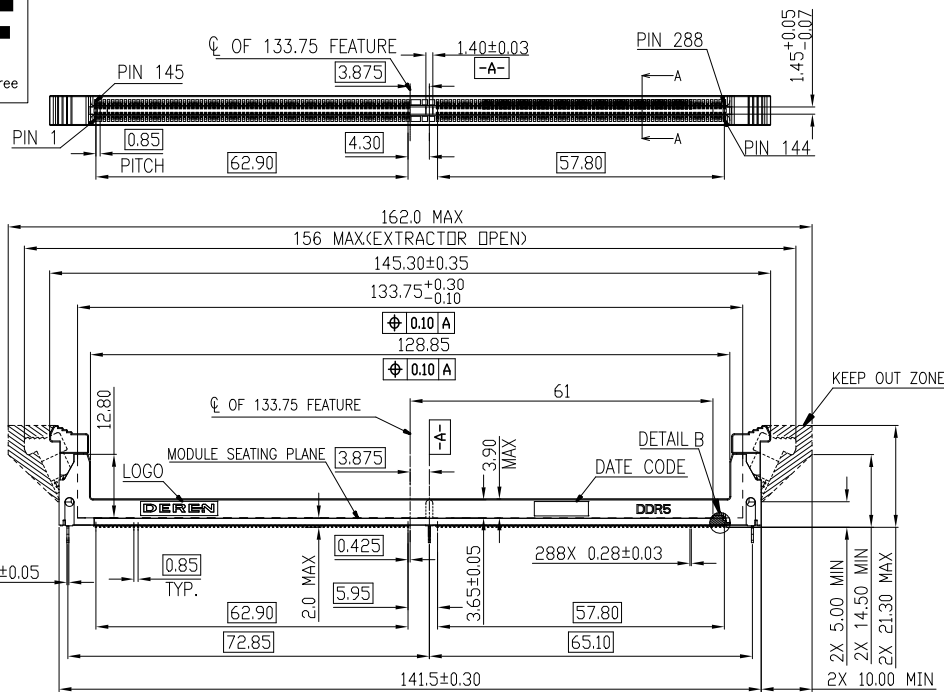
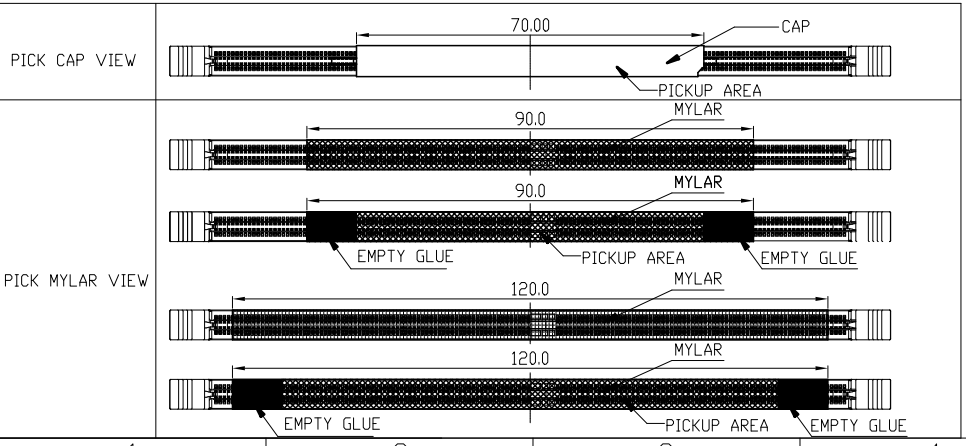

REV	ECN NO.	LOCATION	DESCRIPTION	DATE	DESIGN
A			UPDATE	1/28/21	Zc.Xie
B			UPDATE NEW HARD TRAY	5/17/23	Zc.Xie
C			ADD 120MM MYLAR	8/31/23	Zc.Xie
D			ADD NO LOGO HSG	12/04/23	Yezhijian
E			UPDATE NOTES	01/02/24	Yezhijian

- NOTES:
- PRODUCT MUST MEET CONTROLLED SUBSTANCES SPEC. ROHS 2.0
 - MATERIAL:
 - 1.1 HOUSING: NYLON , UL94V-0; COLOR: SEE P/N INFORMATION.
 - 1.2 EXTRACTOR: NYLON ,UL94V-0; COLOR: SEE P/N INFORMATION.
 - 1.3 CONTACT: COPPER ALLOY .
 - 1.4 FORK LOCK: STAINLESS STEEL.
 - 1.5 METAL SHEET: STAINLESS STEEL
 - FINISH:
 - 2.1 CONTACT:
 - GOLD PLATING(SEE SEE P/N INFORMATION.) ON CONTACT AREA.
 - 2.0um[80u"] MIN. MATTE-TIN PALTING ON SOLDER TAIL AREA.
 - 2.25um[90u"] MIN. NICKEL ON CONTACT AREA,
 - 1.27um[50u"] MIN. NICKEL ON OTHER AREA.
 - 2.2 FORK LOCK:
 - MATTE TIN PALTING 80u"Min ON SOLDER TAIL AREA.
 - 50u" MIN. NICKEL UNDERPLATING OVERALL.
 - REFLOW SOLDER CAPABLE TO 260°C MAX. 10S.
 - MECHANICAL SPECIFICATION:
 - MATING FORCE: 106.8N MAX.
 - UNMATING FORCE: 19.77N MIN.
 - DURABILITY: 25 MATING AND UNMATING CYCLES
 - ELECTRICAL SPECIFICATION
 - CONTACT RESISTANCE: INITIAL:40 MILLIOHMS MAX.,
 - CONTACT RESISTANCE: FINAL: CHANGE 20 MILLIOHMS MAX..
 - CURRENT RATING: 0.75AMPS MAX.
 - INSULATION RESISTANCE: 1 MEGOHMS MIN. AT 500VAC
 - DIELECTRIC WITHSTAND VOLTAGE: 500VAC MIN. FOR ONE MINUTE.
 - ENVIRONMENT SPECIFICATION
 - OPERATING TEMPERATURE: -55°C TO +85°C.
 - SOLDERABILITY: PASSED PER EIA-364-52, CLASS 2, CATEGORY 3.
 - VIBRATION: PASSED PER EIA-364-28.
 - HUMIDITY: PASSED PER EIA-364-31.
 - THERMAL SHOCK: PASSED PER EIA-364-32.
 - MECHANICAL SHOCK: PASSED PER EIA-364-27.
 - PART NUMBER INFORMATION:

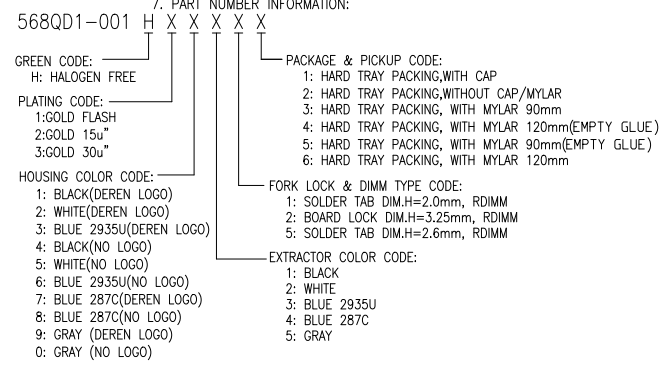

DIM	TOL	DIM	TOL
x.	±0.35	x.	±2*
.x	±0.25	.x	±1*
.xx	±0.20		
.xxx	±0.15		



DEREN
SHENZHEN DEREN ELECTRONIC CO., LTD

C-DWG	TY	DATE	TITLE: DDR5 288PIN SMT RDIMM BIG EXTRACTOR
DESIGN:	Yezhijian	01/02/24	P/N:SEE P/N INFORMATION
CHECK:	Bill Lin	01/02/24	SHEET: 1/3
APPROVAL:	Smarrk Huo	01/02/24	SCALE: NA UNIT: mm

DRAW NO. SC2410128-1

HF
Halogen Free

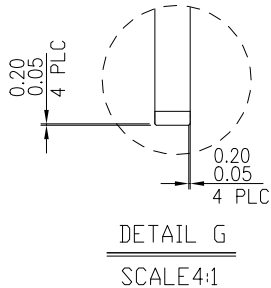
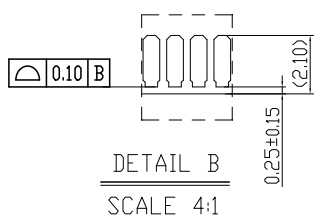
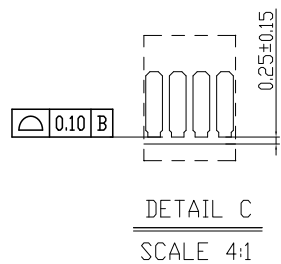
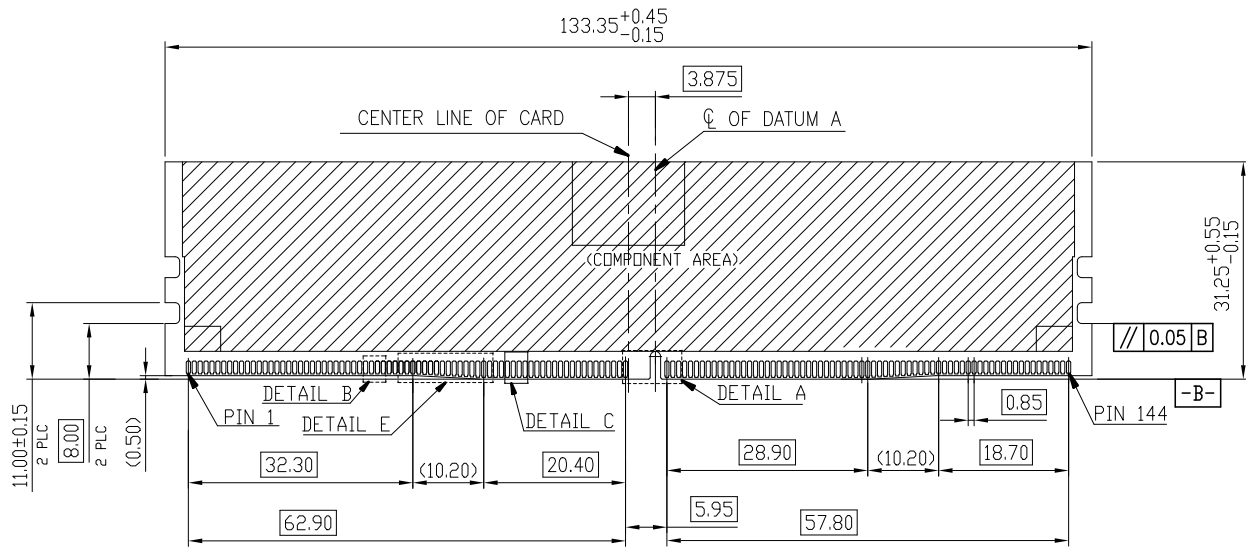
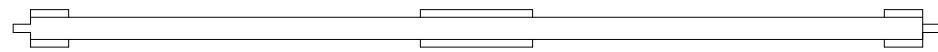
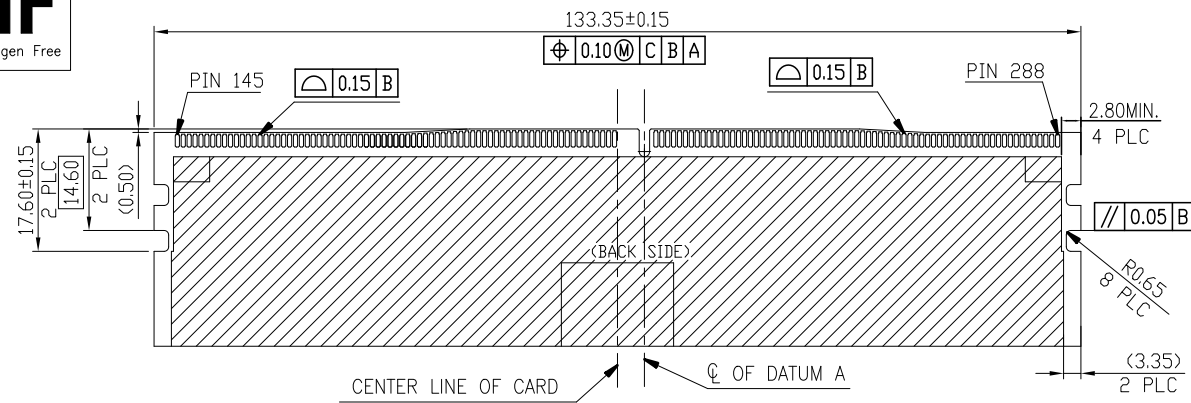

REV.	ECN NO.	LOCATION	DESCRIPTION	DATE	DESIGN
A			UPDATE	1/28'21	ZC.Xie
B			UPDATE NEW HARD TRAY	5/17'23	ZC.Xie
C			ADD 120MM MYLAR	8/31'23	ZC.Xie
D			ADD NO LOGO HSG	12/04'23	Yezhijian
E			UPDATE NOTES	01/02'24	Yezhijian

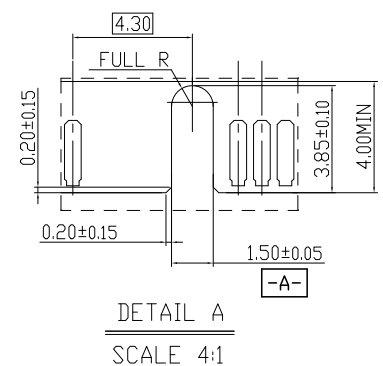
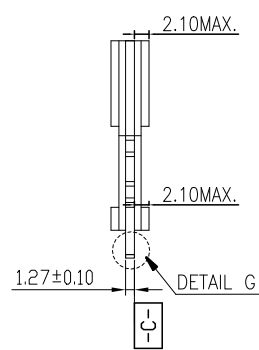
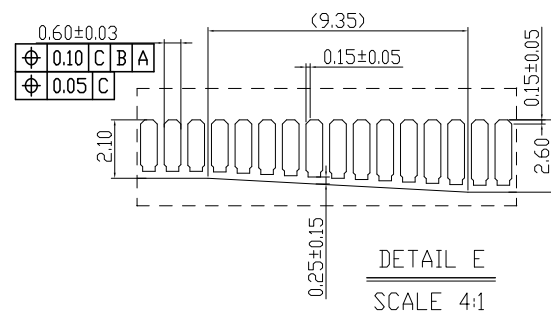

DIM	TOL	DIM	TOL
.x.	±0.35	.x.	±2'
.x	±0.25	.x	±1'
.xx	±0.20		
.xxx	±0.15		

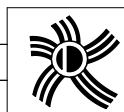

DEREN
SHENZHEN DEREN ELECTRONIC CO., LTD

C-DWG	TY	DATE	TITLE: DDR5 288PIN SMT RDIMM BIG EXTRACTOR
SC2410128-1	Yezhijian	01/02'24	P/N: SEE P/N INFORMATION
DESIGN:	Yezhijian	01/02'24	SHEET: 2/3
CHECK:	Bill Lin	01/02'24	SCALE: NA
APPROVAL:	Smarrk Huo	01/02'24	UNIT: mm

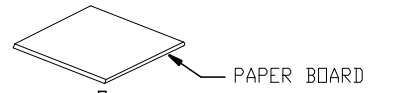

PAPER BOARD

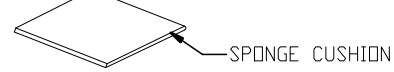

SPONGE CUSHION

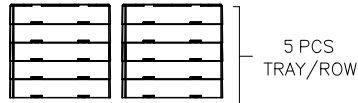

5 PCS TRAY/ROW

TWO ROW

Desiccant

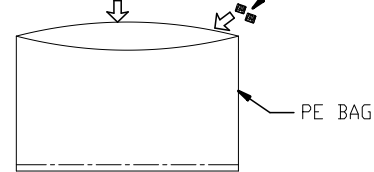

PE BAG

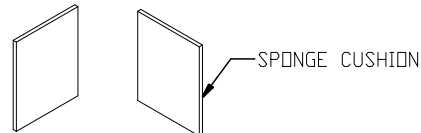

SPONGE CUSHION

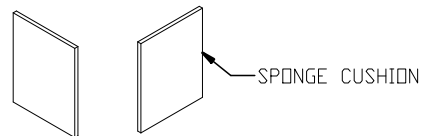

SPONGE CUSHION

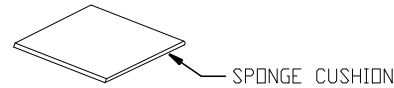

SPONGE CUSHION

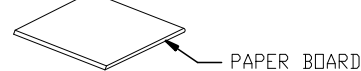

PAPER BOARD

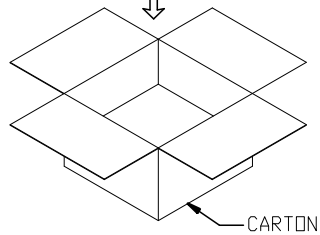

CARTON

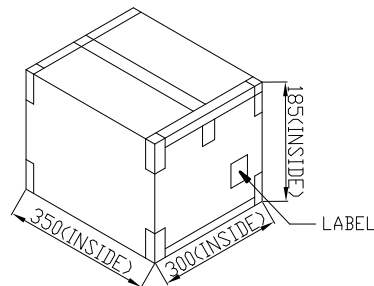
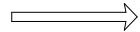

REV.	ECN NO.	LOCATION	DESCRIPTION	DATE	DESIGN
A			UPDATE	1/28'21	ZC.Xie
B			UPDATE NEW HARD TRAY	5/17'23	ZC.Xie
C			ADD 120MM MYLAR	8/31'23	ZC.Xie
D			ADD NO LOGO HSG	12/04'23	Yezhijian
E			UPDATE NOTES	01/02'24	Yezhijian

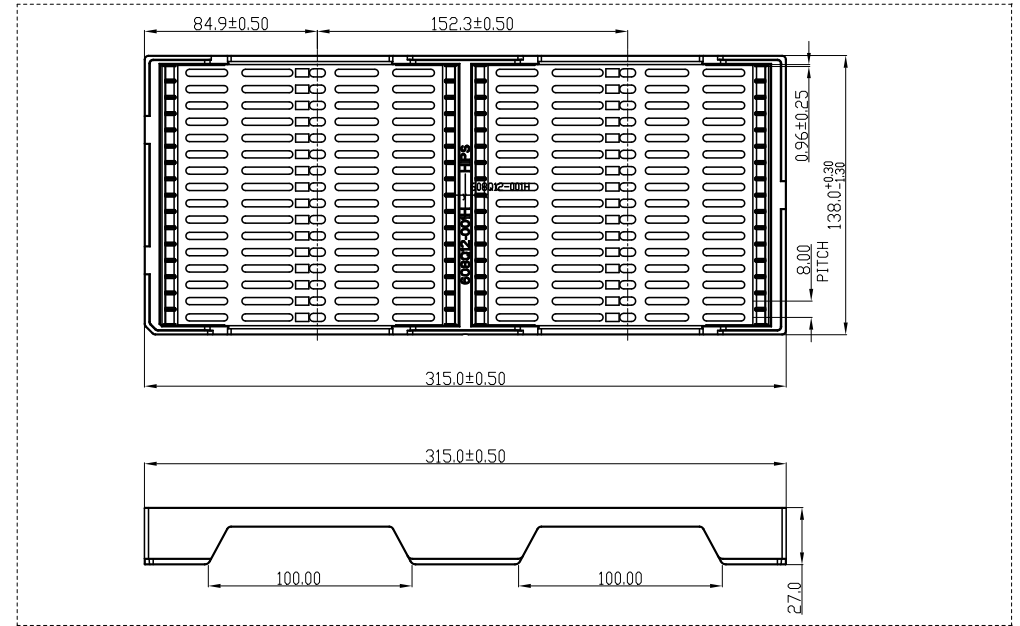

HARD TRAY VIEW

4.35kg	1.86kg	32	10	320
GROSS WEIGHT	NET WEIGHT	PCS/ TRAY	TRAY/ BOX	PCS/ BOX

DIM	TOL	DIM	TOL
.X	±1.00	.X	
.X	±0.50	.X	
.XX	±0.35		

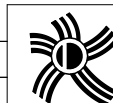

DEREN

SHENZHEN DEREN ELECTRONIC CO., LTD

C-DWG	TY	DATE	TITLE: DDR5 288PIN SMT RDIMM BIG EXTRACTOR
SC2410128-1	DESIGN: Yezhijian	01/02'24	P/N: SEE P/N INFORMATION
REV. E	CHECK: Bill Lin	01/02'24	SHEET: 3/3
APPROVAL: Smark Huo	01/02'24	SCALE: NA	UNIT: mm